

Produits/Rivets-Aveugles/Rivet-Standard/Inox-A2-Inox-A2/

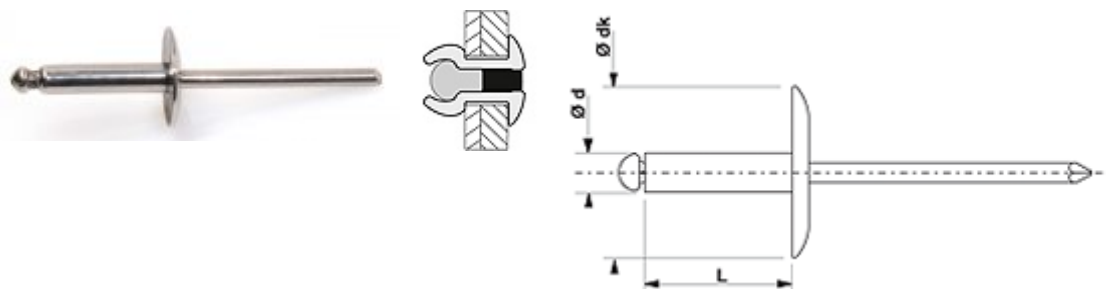





INOX A2 TEL

TÊTE EXTRA LARGE

CONFORME À LA NORME NF EN ISO 15983



INOX A2 INOX A2

Ø	L	DK						BOÎTE CARTON		BOÎTE PLASTIQUE		BLISTER
mm	mm	mm	mm	mm	N	N	qté	ref	qté	ref	qté	ref
3,2	6	10,0	1,0 - 3,0	3,4	2500	1900	500	105 332 061	-	-	-	-
3,2	8	10,0	3,0 - 5,0	3,4	2500	1900	500	105 332 081	-	-	-	-
3,2	10	10,0	5,0 - 7,0	3,4	2500	1900	500	105 332 101	-	-	-	-
4,8	10	16,0	2,5 - 5,0	5,0	5000	4000	250	105 348 101				
4,8	12	16,0	5,0 - 7,0	5,0	5000	4000	250	105 348 121	-	-	-	-
4,8	14	16,0	7,0 - 9,0	5,0	5000	4000	250	105 348 141	-	-	-	-
4,8	16	16,0	9,0 - 11,0	5,0	5000	4000	250	105 348 161	-	-	-	-
4,8	20	16,0	11,0 - 15,0	5,0	5000	4000	250	105 348 201	-	-	-	-
4,8	23	16,0	15,0 - 18,0	5,0	5000	4000	250	105 348 231	-	-	-	-

SUR DEMANDE

Ø 4 - 6,4 - TL - Rivets couleurs

Application

Chauffage
Air conditionné
Ventilation
Equipement industriel
Machines
Four industriel
Boulangerie
Appareil médical